

Operating instructions/spare parts

DOK-289-GB.doc

Rev. 2

Material pressure container

Type **2l/2,5bar, stainless steel**

Article-No.: 5704-090-....

- keep for further use -

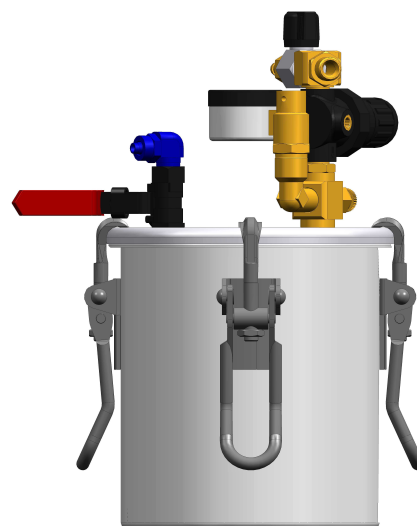

Krautzberger 

	Dokumentation DOK-289 Rev. 2	Description	Pressure container
		Type	2l/2,5bar
		Order-No.	5704-090-....

Contents	
1	Use for intended purpose 2
2	General safety notes 2
3	Start-up 4
4	Shut-down 5
5	Cleaning and maintenance 5
6	Spare parts drawing 6
6.1	Spare parts list 7
7	Technical Data 8

1 Use for intended purpose

Krautzberger material pressure containers are containers with detachable covers in which compressed air can be used to pressurise liquid and low-viscosity materials. The pressurised material can then be routed via suitable hoses and pipes to extraction points (e.g. spray guns or similar). Pressure containers are primarily used in the painting and coating sector.

The temperature of the coating medium may not be below -10°C or above +50°C. Corrosive or highly abrasive materials may only be used following consultation with Krautzberger.

Krautzberger pressure containers are equipped as standard with a material outlet with shutoff device, compressed air connection fitting with overpressure valve, and a pressure gauge for pressure indication.

Pressure containers may be fitted with stirrers, level gauges, filling devices and other accessories.

2 General safety notes

 **Material pressure containers may not be transported in pressurised state!**

 **The construction of pressure containers may not be altered!**

 **Pressure containers may only be operated within the operating parameters (pressure, temperature etc.) specified on the rating plate!**

 **The housing of the pressure containers is made of stainless steel and may have galvanised or enameled surfaces. The operator must check the compatibility of the materials with the coating substances used. Please also refer to the instructions of the manufacturer of the coating substance.**

 **Before opening a pressure container, the compressed air feed must always be shut off and the container rendered pressureless via the venting valve!**

Stirring mechanisms must be switched off and secured against accidental switch-on!

 **Please always read and observe the safety and treatment instructions of the material manufacturer – in particular instructions relating to:**

- the wearing of protective equipment during the use of hazardous substances
- the avoidance of harmful or explosive environments

Description	Pressure container
Type	2l/2,5bar
Order-No.	5704-090-....

 Components connected by the operator (hoses and pipes, fittings, extraction devices etc.) must be reliably able to withstand the loads to be expected during operation of the pressure container (pressure, temperature, chemical and mechanical influences).

Before each operating step, check hoses and pipes for possible damage and ensure that they are firmly connected. Loose, pressurised hoses may cause accidents due to whiplash-like movement and the uncontrolled discharge of fluids.

 Rooms in which hazardous substances are stored or processed must have adequate ventilation. It may be necessary to install a ventilation system.

If the ventilation system fails, work must be stopped immediately and the stirrer switched off.

Always comply with the relevant national and regional regulations.

 Do not store any flammable substances, empty coating substance containers or other materials that have been in contact

with the coating substance (paper, cloths etc.) in the container or in the working zone.

 Do not use halogenated detergents. Chemical reactions may cause explosive and caustic compounds!

 In the working zone, avoid open flames and red-hot components as well as equipment, tools and parts that can create ignitable sparks.

 Hang up "No Smoking" signs in a 5-metre radius of the container. Make fire extinguishers available if these are not already in place!

 Comply with all national and regional water protection regulations!

Comply with all national and regional waste disposal regulations!

3 Connections and items of equipment

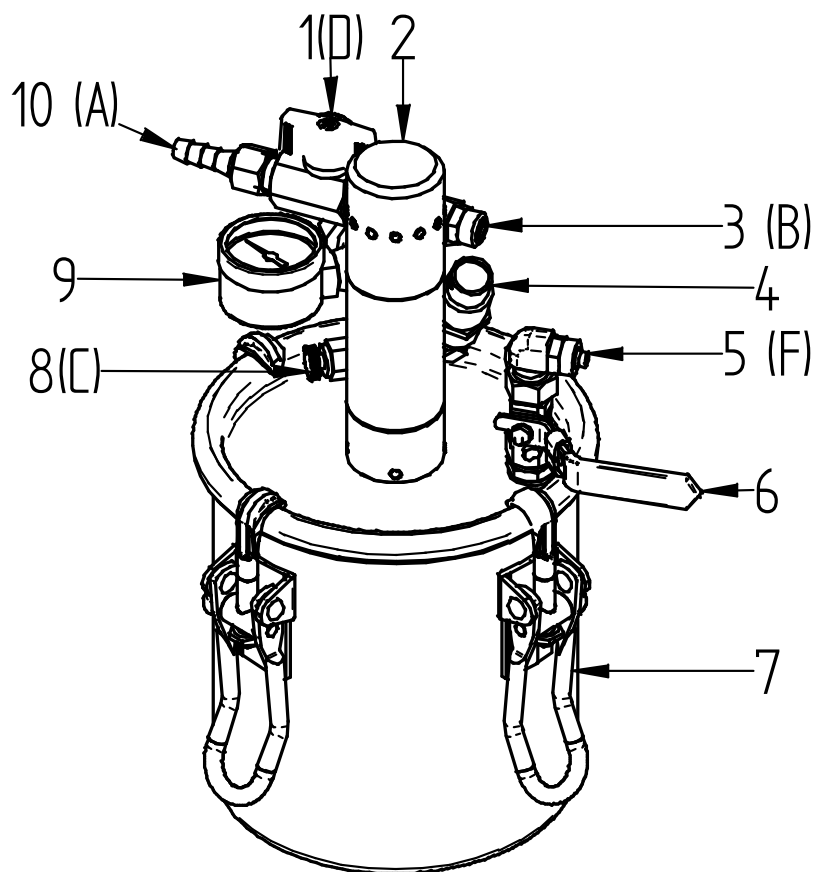

1	Ball cock air supply	6	Ball cock
2	Stirrer (optional)	7	clamp straps
3	compressed air outlet to spray-gun	8	Drain valve
4	Safety valve	9	Pressure gauge
5	material outlet to spray gun	10	Compressed air-connection (max.2,5bar)

4 Start-up

First off all clean container. Loosen clamp straps, remove cover and clean the container inside. Subsequently fill in the agent to be processed up to max level of 35mm below the upper container rim. Put cover on the container thereby making sure that cover gasket (3) is correctly seated and the sealing surface at the container rim is devoid of impurities. Engage clamp straps. In case clamping force is applied un-

evenly, adjust clamping hooks and check them by means of the nuts.

Connect container to the supply lines in accordance with the major letters displayed on the container cover, viz:

A= compressed air inlet from supply net

B= compressed air outlet to spray-gun

F= material outlet to spray gun

Close drain valve (16) and ball clock (22) (compressed air supply for stirrer). As well

Krautzberger 	Dokumentation DOK-289 Rev. 2	Description	Pressure container
		Type	2l/2,5bar
		Order-No.	5704-090-....

as ball cock (5) (material outlet). Open ball cock (18) (compressed air inlet), container is now pressurized. Container pressure = material pressure – is regulated by means of pressure regulator (9) and displayed at pressure gauge (11).

Now open ball cock (22) (compressed air supply for stirrer) and ball cock (5) (material outlet), container is now ready for operation.

5 Shut-down

In case of extended shut-downs, all parts and surfaces eligible to get in contact with processed agent. Must be rinsed and cleaned by means of appropriate cleaning

agent. In the process pay attention that the cleaning agent does not penetrate into the instruments mounted on top of the container!

6 Cleaning and maintenance

With regard to cleaning, refer to section above “shut down”. In case of container leakages, replace the pertinent gaskets. Slightly grease from time to time movable parts.

7 Spare parts drawing

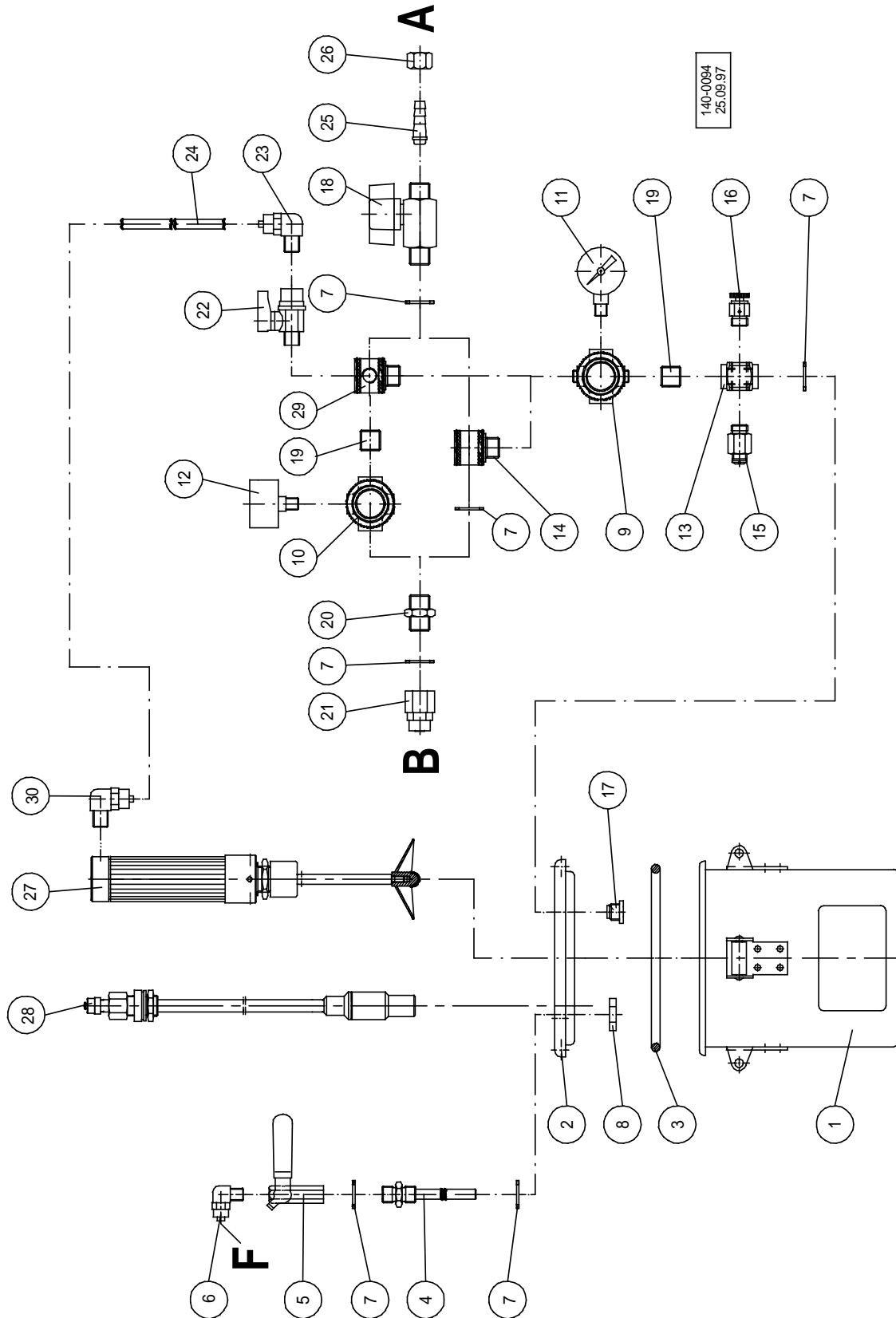

	Dokumentation DOK-289 Rev. 2	Description	Pressure container
		Type	2I/2,5bar
		Order-No.	5704-090-....

7.1 Spare parts list

Pos.	Article-No.	Designation
1	5704-080-0695	Container, compl.
2	5704-080-0785	Cover
3	5704-010-0194	Gasket, EPDM (standard)
	5704-010-0169	Gasket FKM
4	5704-080-0168	Riser pipe
5	5704-030-0968	Ball valve
6	6903-030-0822	Angular screwing
7	5704-010-0174	Gaskets (nos 6)
8	5704-040-1157	Counter nut
9	5704-090-0278	Pressure regulator, 2,5bar
10	5704-030-2021	Pressure regulator, 6,0bar
11	6825-030-1034	Pressure gauge, 2,5bar
12	6826-030-1061	Pressure gauge, 6,0bar
13	5704-030-2128	Cross distributor
14	5704-030-2122	Screw-in distributor
15	5704-130-0087	Safety valve, 2,5bar
16	5704-130-0106	Drain valve
17	5704-040-3577	Fitting
18	6915-030-0982	Ball valve
19	5704-040-1167	Pipe nipple (nos 2)
20	5704-030-2235	Double nipple
21	6903-030-0816	Screwing
22	6915-030-0963	Ball valve
23	6903-030-0820	Angular screwing
24	5704-100-0322	Hose 0,225m
25	6902-040-0822	Sleeve
26	6902-040-0821	Screw cap
27	6313-090-0259	Agitator
28	9200-090-0690	Level gauge, compl.
29	5704-030-2123	Screw-in distributor
30	6903-030-0821	Angular screwing

8 Technical Data

Max. operating pressure	2,5bar
Max. operating temperature	+50°C
compressed air connection	hose, diam.Ø 8/9
Material connection	Hose pl-6
Weight (depending on option)	2,4-4,3kg

